

# DH-PFA102

## Mount Adapter



### Features

- Aesthetic design
- Material: aluminum
- Mount adapter

### Technical Specifications

<b>Model</b>	<b>DH-PFA102</b>
<b>General</b>	
Material	Aluminum
Dimension	Φ169mmx37mm (Φ6.65"x1.46")
Pipe Thread	G1 1/2"
Load Bearing	3.0kg(6.61lb)
Weight	0.25kg(0.55lb)
Color	White
Operating Temperature	-40°C ~ +60°C (-40°F ~ +140°F)
Humidity	<90% RH
Applicable Model	Please see "Accessory Selection"

### Order Information

Type	Part Number	Description
Camera Mount	DH-PFA102	Mount adapter
	PFA102	Mount adapter

### Dimensions (mm/inch)

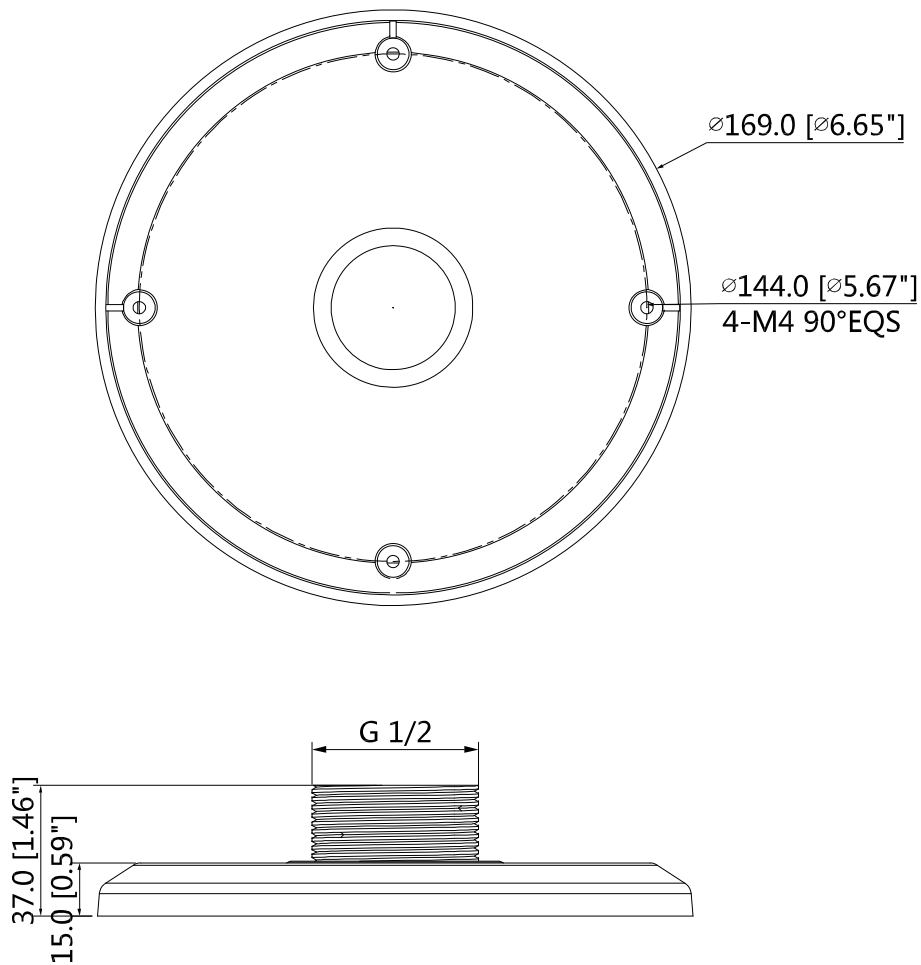

## Application

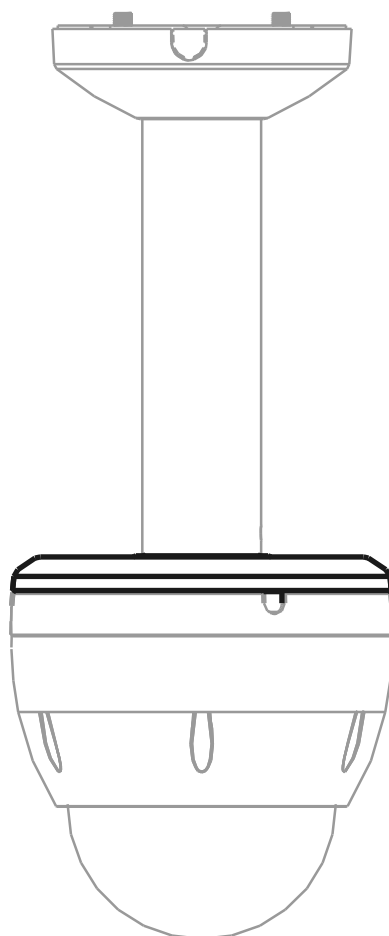

## Package Information

- Mount adapter \*1